

# evenflo®

## SureRide™/Titan® 65 Child Restraint System

### Owner's Manual

Keep for future use.

#### Rear-facing\*

2.3 to 18 kg  
(5 to 40 lbs)

48 to 102 cm  
(19 to 40 in.)

#### Forward-facing\*

10 to 29.4 kg  
(22 to 65 lbs)

71 to 137 cm  
(28 to 54 in.)

At least 2 years old

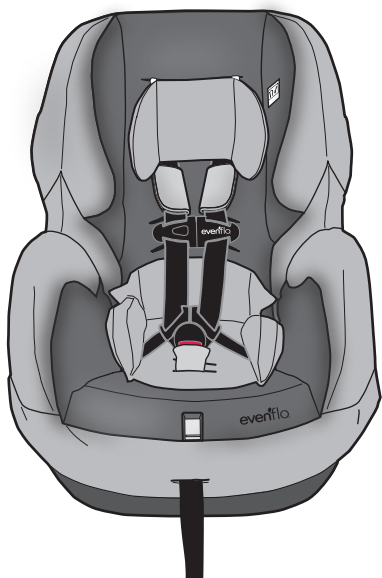

\* See page 2 for complete requirements.

Para instrucciones en Español,  
llamar al: 1-800-233-5921

### **⚠️ WARNING:**

To reduce the risk of serious injury  
or death, read this owner's manual prior  
to installing and using this child restraint.

**More children are killed every year as passengers in car crashes than by any other type of injury.**

To reduce the risk of **SERIOUS INJURY** or **DEATH**, read this owner's manual and your vehicle owner's manual before installing and using this child restraint. Using a child restraint makes a big difference. By properly using this child restraint and following these instructions (and the instructions that accompany your vehicle), you will greatly reduce the risk of serious injury or death to your child from a crash. Do not be misled by the commonly used term "safety seat"; no restraint system can prevent all injuries in all crashes. Many properly restrained adults and children are injured in motor vehicle crashes, including relatively minor crashes. A properly used child restraint is the best way to minimize injuries to your child and to increase the chances for your child's survival in most crashes.

**U.S. REGULATORY NOTICE**

*This child restraint meets all applicable requirements of Federal Motor Vehicle Safety Standard 213.*

**CANADIAN REGULATORY NOTICE  
(Model numbers ending in "C.")**

*This child restraint meets all applicable requirements of Canadian Motor Vehicle Safety Standards CMVSS 213 and 213.1.*

**Symbol Legend**

---



**Airbag Symbol** – Alerts you to important information about airbag safety.



**LATCH Symbol** – Alerts you to important information about LATCH safety.



**Tether Anchor Symbol** – Alerts you to important information about Tether Anchor safety.



**Aircraft Symbol** – Alerts you to important information about aircraft safety.

# Table of Contents

## **Important Information**

Child Requirements.....	2
Premature Infant Use.....	3
Warnings.....	4
LATCH Warnings .....	8
Safe Practices .....	10
Recall Information for U.S. Customers .....	10
Public Notice for Canadian Customers .....	11
Motor Vehicle/Aircraft Usage .....	11
Storing Your Instructions .....	11
Visual Glossary .....	12
Child Restraint Features.....	14

**Important**

## **Rear-facing Use**

Rear-facing Installation Checklist .....	17
Rear-facing Installation with Lower Anchor Connectors.....	18
Rear-facing Installation with Seat Belt.....	22

**Rear-facing**

## **Forward-facing Use**

Forward-facing Installation Checklist .....	27
Forward-facing Installation with Lower Anchor Connectors.....	28
Forward-facing Installation with Seat Belt.....	32

**Forward-facing**

## **General Information**

Positioning the Harness Strap.....	36
Adjusting the Recline Stand.....	38
Securing the Child in the Child Restraint .....	41
Adjusting the Crotch Strap .....	42
Adjusting the Harness Strap .....	43
Removing the Child from the Child Restraint.....	44
Removing the Tether Strap.....	44
Removing the Lower Anchor Connectors .....	46
Installing the Optional Accessories .....	48
Securing Your Child Restraint in Aircraft .....	50
Installing Child Restraint Rear-facing in Aircraft.....	50
Installing Child Restraint Forward-facing in Aircraft...	53
Care and Cleaning .....	55
Replacement Parts.....	56
Limited Warranty.....	57

**General**

## CHILD REQUIREMENTS

**Warning:** Failure to follow these Child Requirements could result in serious injury or death.

This child restraint is designed for use by children in both **rear-facing** and **forward-facing** orientations. To use this child restraint properly, children **MUST** meet the size and age requirements below. In addition, Evenflo recommends consulting with your child's physician before allowing your child to transition from **rear-facing** to **forward-facing** use of this child restraint.

The American Academy of Pediatrics (AAP) recommends keeping children **rear-facing** until they reach the maximum height or weight for their child restraint in **rear-facing** orientation. Additionally, some states' laws require children to be **rear-facing** until age 2. Accordingly, you will see this guidance reflected in the Child Requirements below. Please review any applicable local, state or provincial laws related to child passenger safety before installing and using this child restraint.

### **Rear-facing**

- 2.3 to 18 kg (5 to 40 lbs)
- 48 to 102 cm (19 to 40 in.) and top of child's head is at least 25 mm (1 in.) below the top of the child restraint seat back.

**IMPORTANT:** Once your child **exceeds** any of the size requirements above, they **MUST** use this child restraint in the **forward-facing** orientation, if possible. If your child **exceeds** any of the size requirements above **and** is less than 2 years old, however, you **MUST** discontinue use of this child restraint.

### **Forward-facing**

- 10 to 29.4 kg (22 to 65 lbs)
- 71 to 137 cm (28 to 54 in.) and tops of the child's ears are at or below the top of the child restraint seat back
- At least 2 years old

**IMPORTANT:** Once your child **exceeds** any of the size requirements for **forward-facing** use above, you **MUST** discontinue use of this child restraint. Consider use of a booster seat at that time.

## PREMATURE INFANT USE

*Before using this child restraint for preterm or low birth weight infants, ensure the Child Requirements are met and follow the guidelines in this section.*

According to the U.S. National Highway Traffic Safety Administration, a properly installed child restraint reduces the risk of death by over 70 percent for infants involved in crashes. Federal Motor Vehicle Safety Standard (FMVSS) 213 establishes design and dynamic performance requirements for child restraint systems. However, the standard has no minimum weight limit and does not address the special medical needs of preterm or low-birth weight infants. To ensure that preterm and low-birth weight infants are transported safely, the guidelines published by the American Academy of Pediatrics (AAP) in Pediatrics 2009; 123:1424–1429 must be followed.

All children should ride rear-facing in the vehicle as long as possible. Preterm and low-birth weight infants are at additional risk of breathing difficulties and heart problems when placed in a child restraint. Evenflo requires that the evaluation recommended by the AAP be conducted for all infants born earlier than 37 weeks and all newborn infants who weigh less than 5 pounds at birth before their first car trip to check for breathing difficulties or heart rate problems when traveling in a rear-facing child restraint.

The AAP recommends that appropriate hospital staff observe your infant in the child restraint for a period of 90 to 120 minutes or the duration of travel, whichever is longer. This period of observation must be performed with the infant properly positioned as described in these instructions and with the child restraint placed at an angle that is approved for use in the vehicle. The hospital staff will check for any breathing difficulties or heart rate problems. Your child's pediatrician will let you know if there are any special considerations for travel. The number of trips and the duration of time the infant is seated in the child restraint should be minimized. A caregiver should ride in the back seat to monitor the infant during travel.

You can learn more about the AAP's recommendations for observation of newborns and the guidelines for safe transportation of preterm and low-birth weight infants, as well as other resources for parents and medical professionals, at

**<https://www.healthychildren.org/english/safety-prevention/on-the-go/Pages/default.aspx>**

# **⚠ WARNING**



## **Air Bag Warnings**

- **DO NOT** use this child restraint in the front seat of a vehicle equipped with an air bag, unless the air bag has been deactivated. Air bags may cause serious injury or death to children under 12. If your vehicle has an air bag, please refer to your vehicle owner's manual for child restraint installation.
- If the rear seat of your vehicle is equipped with side air bags, refer to the following information for proper usage:  
**Vehicles built prior to the 2002 model year:**  
**DO NOT** use this restraint in a vehicle seating position equipped with a side air bag unless authorized by the vehicle manufacturer.  
**Model year 2002 and newer vehicles:** Refer to your vehicle owner's manual before placing this restraint in a seating position equipped with a side air bag. **DO NOT** place any objects between the restraint and the side air bag, as an expanding air bag may cause the items to strike your child.

*The forward-facing rear seat is the safest place for children 12 and under.*

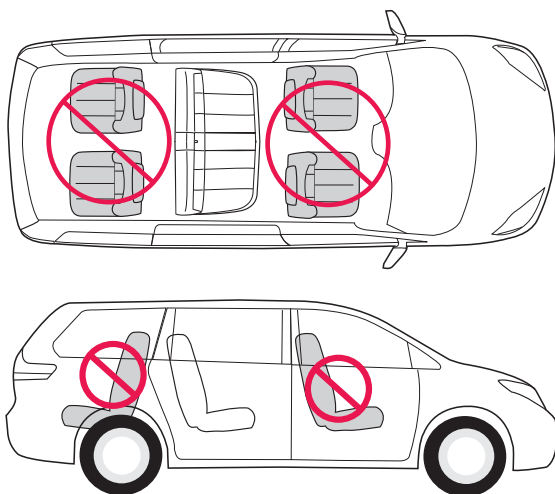



# **⚠ WARNING**

## **General Warnings**

### *Rear-facing and Forward-facing Use*

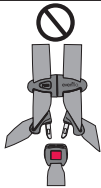
- Failure to follow the Child Requirements for **rear-facing** and **forward-facing** use of this child restraint could result in serious injury or death. (See page 2 for Child Requirements).
- Failure to follow these installation instructions and the instructions and warnings on the product can result in the child striking the vehicle's interior during a sudden stop or crash. Serious injury or death may result. These instructions and the instructions in your vehicle owner's manual must be followed carefully. If there is a conflict between the two, the vehicle owner's manual regarding child restraint installation must be followed.
- **NEVER** leave child unattended.
- Children have **STRANGLER** in loose or partially buckled harness straps. Fully restrain the child.

<b>⚠ WARNING</b>		
		Children have <b>STRANGLER</b> in loose or partially buckled harness straps. Fully restrain the child.

- **DO NOT** use child restraint if it is damaged, broken, or missing parts.
- **DO NOT** use this restraint if it has been involved in a crash. It must be replaced.

## **Location Warnings**

### *Rear-facing and Forward-facing Use*

- **ALWAYS** read and follow exactly the instructions that accompany your vehicle and child restraint.
- According to statistics, children are safer when properly restrained in a rear seating position than in the front seating position. Generally, the center rear position is safest and should be used if available.
- Some child restraints do not fit all vehicles or all seating locations. There are many thousands of combinations of vehicle makes, models, child restraint configurations, vehicle seat belt designs, and seat cushion shapes. The easiest way to determine whether your child restraint is suitable for a particular seating position is to check for a tight installation. If the child restraint cannot be properly installed, **DO NOT** use the child restraint. Consult vehicle owner's manual, try a different seating location, or call Evenflo for further assistance.

# **WARNING**

## **Location Warnings** – *continued*

### **Rear-facing and Forward-facing Use**

- **ONLY** use this child restraint on **forward-facing vehicle seats**. **DO NOT** use this restraint with vehicle seats that face the rear or side.
- **ONLY** use this child restraint on vehicle seats with backs that lock into place.

### **Rear-facing Only Warnings**

- When using this restraint rear-facing, **DO NOT** loosen the vehicle seat belt to provide more leg room, as this may keep the child restraint from protecting the child.
- **DO NOT** use the highest set of harness slots rear-facing. The harness will not properly restrain the child during a crash.
- Fold-down armrests could pose a hazard to a rear-facing child in certain types of collisions. Consult your vehicle owner's manual before installing any rear-facing child restraint in front of a fold-down armrest.
- **NEVER** turn a child restraint forward-facing with a child who weighs less than 10 kg (22 lbs). Crash forces may cause serious injury or death.
- **DO NOT** use the tether strap when the child restraint is in the rear-facing position.
- The headrest on the vehicle seat that the child faces when sitting in the rear-facing mode should be placed in the lowest position. The vehicle seat back that the child faces must be fully padded and free of any hard objects.

### **Forward-facing Only Warnings**

- If your child weighs more than 29.4 kg (65 lbs) or their shoulders are above the highest harness level, you **MUST** discontinue using this child restraint as it may no longer adequately protect your child.
- **MUST** be at least 2 years old.
- **DO NOT** use the lowest set of harness slots forward-facing. The harness will not properly restrain the child during a crash.
- **Adjust, or remove, the vehicle headrest in the seat where the child restraint is to be installed**, so that the back of the child restraint rests against the vehicle seat back.



# **WARNING**

## ***Forward-facing Only Warnings – continued***

- The headrest on the vehicle seat in front of the child should be put in its lowest position. The vehicle seat back that the child faces must be fully padded and free of any hard objects.

## ***Seat Belt Warnings***

### ***Rear-facing and Forward-facing Use***

- **DO NOT** use this child restraint if it moves more than 25 mm (1 in.) side to side or front to back at either the rear-facing or forward-facing belt path on the child restraint. Serious injury or death may result from poor installation. If you cannot tightly secure the child restraint, try again or move it to another location.
- **DO NOT** use this child restraint in a seating position with door-mounted seat belts.
- **DO NOT** use this child restraint in a vehicle with seat belts that automatically move along the vehicle frame when the door is opened. These seat belts will not hold a child restraint properly.
- **DO NOT** use this child restraint in a vehicle equipped with lap belts that only lock during a sudden stop or crash (emergency locking retractor – ELR). You must use a seating location with a locking seat belt. Check your vehicle owner's manual to see if you have lap belts with ELRs.
- If the vehicle seat belts are not routed and fastened correctly, the child restraint may not protect the child in a crash.
- **DO NOT** allow the vehicle seat belt release button to touch the child restraint. Accidental contact may cause the seat belt to release. If necessary, turn the seat belt release button away from the child restraint or move the child restraint to a different location.
- Failure to adjust the harness or vehicle seat belts snugly around the child may result in the child striking the vehicle's interior during a sudden stop or crash. Serious injury or death may occur.

# **WARNING**

## **LATCH Warnings**

### *Rear-facing and Forward-facing Use*

- Do not use the lower anchors of the child restraint anchorage system (LATCH System) to attach this child restraint when restraining a child weighing more than 24.9 kg (55 lbs) with the internal harnesses of the child restraint.
- The LATCH system is intended to be used **ONLY** as described in these instructions. Serious injury or death may result from misuse. **LATCH** (**L**ower **A**nchors and **T**ethers for **C**hildren) is a system for attaching the child restraint to your vehicle seat. It can be used in place of the seat belts in vehicles with vehicle lower anchor bars. Refer to your vehicle owner's manual for the locations of the vehicle lower anchor bars. **Note:** Your vehicle owner's manual may refer to this system as "Universal Anchorage System (UAS)," "Lower Universal Anchorage System," or "ISOFIX."
- In addition to these instructions, read and follow your vehicle owner's manual regarding installation of the child restraint and LATCH. If there is a discrepancy, follow your vehicle owner's manual.
- **ONLY** use for securing child restraint to vehicle lower anchor bars.
- **NEVER** attach two lower anchor connectors to one vehicle lower anchor bar.
- **NEVER** use the vehicle seat belts when using the Lower anchor connector assembly. Using both together can cause slack in a sudden stop or crash.
- To avoid strangulation, you must store the unused LATCH harness, with all slack removed, in the storage area on the back of the seat. Roll or fold the excess LATCH strap and secure with a rubber band to prevent serious injury to vehicle occupants.
- **ALWAYS** be sure that the lower anchor connectors are attached to the vehicle lower anchor bars by pulling hard on the lower anchor connectors. If they are not attached, the lower anchor connector assembly will not secure your child restraint. Serious injury or death may result.
- **DO NOT** use this child restraint if it moves more than 25 mm (1 in) side to side or front to back at either the rear-facing or forward-facing belt path on the child restraint. Serious injury or death may result from poor installation. If you cannot tightly secure the child restraint, try again or move it to another location.

# **⚠ WARNING**



## **Tether Strap Warnings**

### ***Forward-facing Use Only***

- To avoid a strangulation hazard, you **MUST** tightly roll or fold excess or unused tether strap and secure with a rubber band. Attach the tether hook to the storage clip when not in use (p. 14). This will keep an unused tether or tether hook from hitting someone during a crash.

### **Additional Warnings**

#### ***Rear-facing and Forward-facing Use***

- In hot or sunny weather, **ALWAYS** check the areas of the child restraint that may contact your child (e.g., buckle, buckle tongues, etc.) for hot areas before placing him/her into the child restraint. The child could be burned. Cover the child restraint with a light colored blanket when you leave the vehicle.
- This child restraint must be securely fastened to the vehicle, **even when unoccupied**, using the vehicle seat belts or lower anchor connectors. An unsecured child restraint may injure someone if a crash occurs.
- **DO NOT** use the cup holder to store cans or hard cups. Only for use with soft cups.
- **DO NOT** place any cups that contain hot liquids in the cup holder.
- **DO NOT** attach additional padding, toys, or other devices not made by Evenflo or described in these instructions for the child restraint. Items not tested with the child restraint could injure the child. Additional pads or pillows may interfere with the function of the harness system, or cause breathing problems if the child's head falls forward, increasing the risk of serious injury or death.
- In cold weather, **DO NOT** dress the child in bulky clothing like snowsuits if the child is riding in a child restraint. Bulky coats/snowsuits make it difficult to properly tighten the harness to the child, which may allow the child to be ejected from the restraint during a crash. If necessary, place a blanket over the harnessed child without interfering with the child restraint harness system.

## ***Safe Practices***

---

- **Everyone rides buckled up or the vehicle does not go.** Make no exceptions for adults or children. If someone unbuckles, stop the vehicle. Being firm and consistent from the start will mean fewer discipline problems as children get older. An unrestrained person can be thrown into and injure other passengers.
- Many safety advocates and healthcare professionals recommend that children ride rear-facing for as long as possible. See limitations recommended on rear-facing use on page 2.
- **NEVER** try to tend to a crying baby's needs while driving. **NEVER** take a baby out of a child restraint for comforting while the vehicle is moving.
- **DO NOT** allow a child in a vehicle to have objects such as lollipops or ice cream on a stick. The object can injure the child if the vehicle swerves or hits a bump.
- **DO NOT** feed an infant who is riding in a child restraint.
- Put sharp or heavy items in the trunk. Anything loose can be deadly in a crash.
- **DO NOT** dress the child in blanket sleepers or other clothing that would prevent the crotch strap from fitting snugly up against the child.

## ***Recall Information for U.S. Customers***

---

- Child restraints could be recalled for safety reasons. You must register this restraint to be reached in a recall. Send your name, address, e-mail address if available, and the restraint's model number and manufacturing date to:  
**Evenflo Company, Inc.,**  
**1801 Commerce Dr.,**  
**Piqua, OH 45356**  
or call 1-800-233-5921.  
or register online at:  
**[www.evenflo.com/registercarseat](http://www.evenflo.com/registercarseat)**
- For recall information, call the U.S. Government's Vehicle Safety Hotline at 1-888-327-4236 (TTY:1-800-424-9153), or go to: **<http://www.NHTSA.gov>**

## Public Notice for Canadian Customers

- Child restraints could be recalled for safety reasons. You must register this restraint to be reached in a recall. Send your name, address, and the restraint's model number and manufacturing date to:

**Evenflo Company, Inc.,  
1801 Commerce Dr.,  
Piqua, OH 45356**

or call 1-937-773-3971.

or register online at:

**[www.evenflo.com/registercarseatcanada](http://www.evenflo.com/registercarseatcanada)**

- For public notice information, call Transport Canada at 1-800-333-0510 (1-613-993-9851 in Ottawa region).

### Motor Vehicle/Aircraft Usage

**When used with the internal harness and properly installed pursuant to these instructions,** this restraint is certified for use only in passenger and multi-purpose passenger motor vehicles, buses and trucks equipped with either lap belts only or lap/shoulder belt systems and in aircraft.

Refer to pages 50 to 54 for instructions on installing your child restraint in aircraft.



### Storing Your Instructions

After thoroughly reading and following these instructions, **store the instructions in the clips on the sides of your child restraint.**

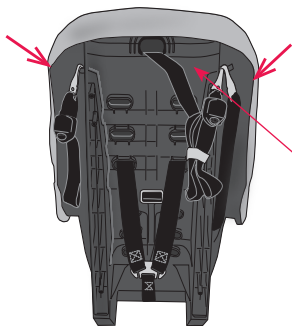

Manufactured in / Fabriqué en  
(year-month-day)/(année-mois-jour)  
Name / Nom  
Model / Modèle  
Made in / Fabriqué en  
Expires on/Expire le

For future reference, record the **model number** of your child restraint **AND** the **date of manufacture** below.

**Model Number:** \_\_\_\_\_

**Date of Manufacture:** \_\_\_\_\_

# Visual Glossary

Your vehicle components may be significantly different than pictured. Consult your owner's manual to help you identify your vehicle components.

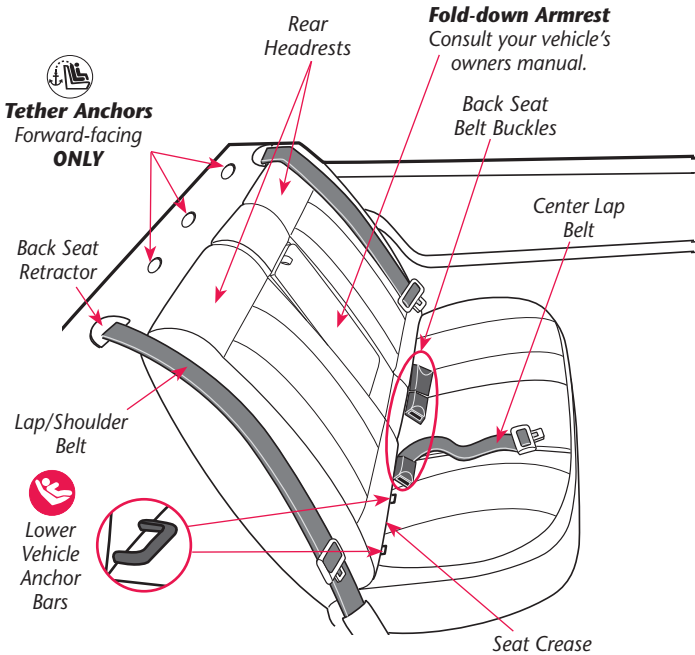

**IMPORTANT:** If your vehicle has **side air bags**, please refer to the warnings on page 4.

## Front Seat Lap and Shoulder Belts

Front Headrests

<b>⚠ WARNING</b>	
	<b>DO NOT</b> place rear-facing child seat on front seat with air bag. <b>DEATH or SERIOUS INJURY can occur.</b> The back seat is the safest place for children 12 and under.

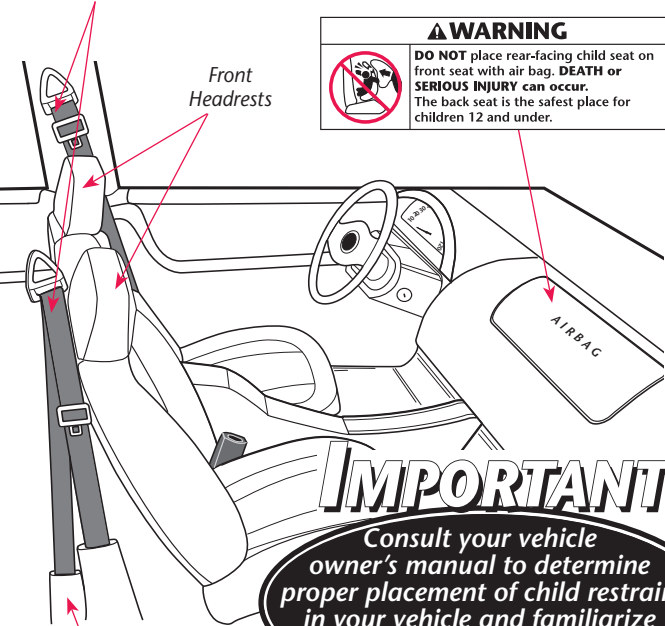

Front Seat Retractor

# IMPORTANT

Consult your vehicle owner's manual to determine proper placement of child restraint in your vehicle and familiarize yourself with your vehicle's components.

# Child Restraint Features

## Front View

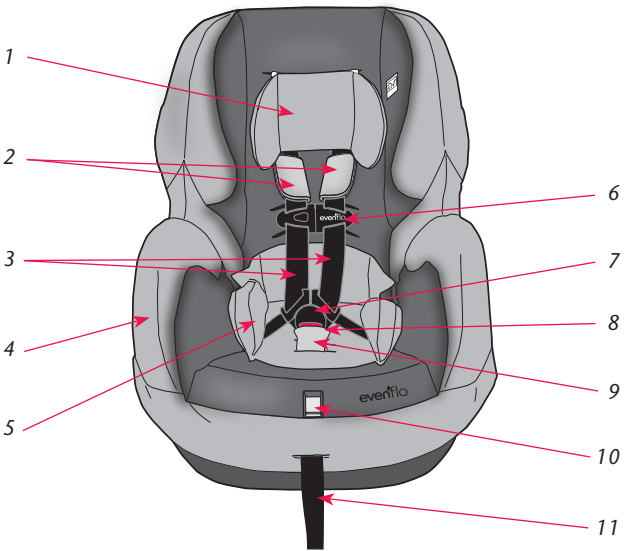

## Back View

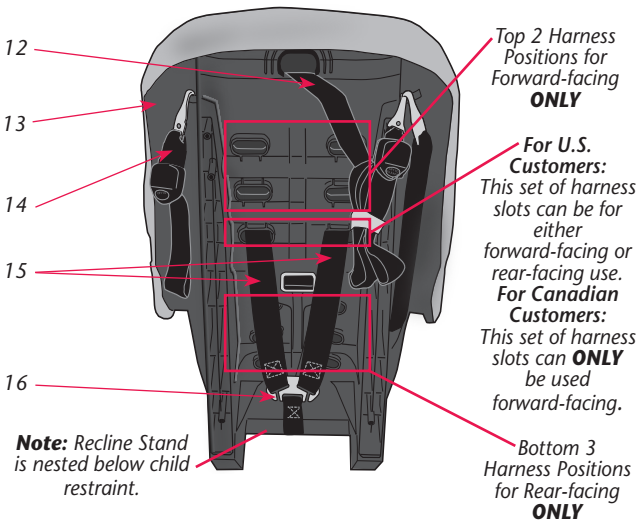



## Description

1. Head Pillow
2. Harness Covers\*
3. Harness Straps
4. Seat Pad
5. Body Pillow
6. Chest Clip
7. Buckle
8. Crotch Strap
9. Buckle Cover\*
10. Harness Release Button
11. Harness Adjuster Strap
12. Tether Strap and Hook
13. Instruction Storage Area
14. Lower Anchor Connector Assembly
15. Harness Straps
16. Splitter Plate

\* Not all features are available on all models. Styles may vary.

# Using the Child Restraint Rear-facing

## Child Requirements:

- **Weight:** 2.3 to 18 kg (5 to 40 lbs)
- **Height:** 48 to 102 cm (19 to 40 in.) and top of child's head is at least 25 mm (1 in.) below the top of the child restraint seat back

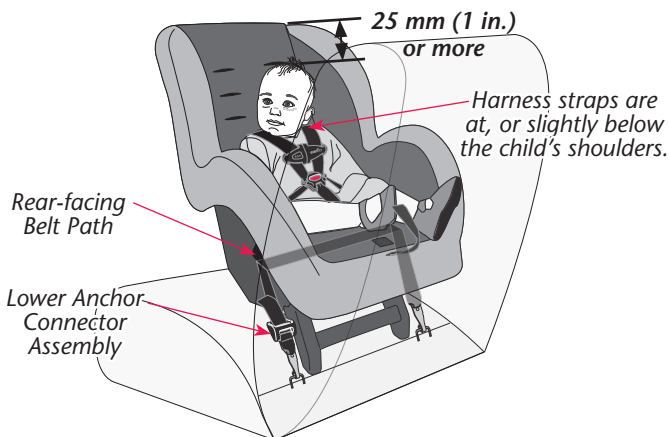

**IMPORTANT:** Once your child **exceeds** any of the size requirements above, they **MUST** use this child restraint in the **forward-facing** orientation, if possible. If your child **exceeds** any of the size requirements above **and** is less than 2 years old, however, you **MUST** discontinue use of this child restraint.

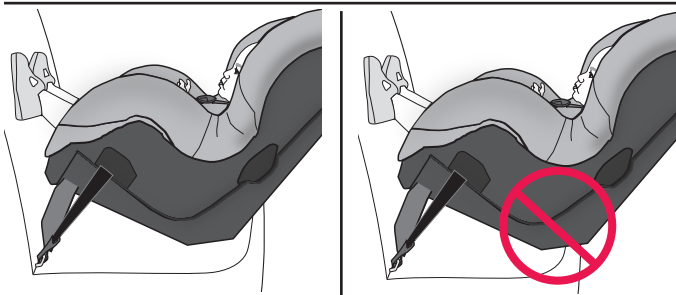

**Note:** When in rear-facing position, bottom of child restraint **MUST** be entirely on vehicle seat.

# Rear-facing Installation Checklist

## 1. Secure child restraint to the vehicle seat.

- Recline stand is flipped to the **recline** position (page 38).
- Install with Lower Anchor Connector Assembly (page 18) **or** vehicle seat belt (page 22).
- Towel rolled up and placed beneath the recline stand, if necessary (page 40).
- Install locking clip, if necessary (page 24).

## 2. Set the child in the child restraint.

Top of head is at least 25 mm (1 in.) below the top of the child restraint seat back.

## 3. Fasten the buckle.

Refer to page 41.

## 4. Make necessary adjustments.

- Crotch strap is snug against the child (page 42).
- Harness straps **MUST** be snug against the child's shoulders, with no slack (page 41).

## 5. Position and connect chest clip.

Chest clip **MUST** be at armpit level (page 41).

## 6. Check your work.

- Recline stand is flipped to the **recline** position (page 38).
- To properly secure this child restraint it **MUST NOT** move more than 25 mm (1 in.) from side to side or front to back at the rear-facing belt path (pages 21 and 25).
- The child's back and bottom are flat against the back and bottom surfaces of the child restraint (page 41).
- Shoulder harness straps **MUST** start at or below shoulder height using the strap slots closest to your child's shoulders (page 36).
- Buckle tongues are fully engaged (page 41).
- The level arrow is level with the ground (pages 18 and 22).

## **WARNING**

When using this restraint rear-facing, **DO NOT** loosen the vehicle seat belt to provide more leg room, as this may keep the child restraint from protecting your child.



## Rear-facing Installation with Lower Anchor Connectors

LATCH is a system for attaching the child restraint to your vehicle seat. It is to be used in place of your vehicle's seat belts and can be used in vehicles with LATCH anchors. **DO NOT install this child restraint with LATCH and the vehicle's seat belts. Your vehicle owner's manual may refer to this system as ISOFIX, Universal Anchorage System (UAS), or Lower Universal Anchorage System.**

### **⚠ WARNING**

To avoid a strangulation hazard, you **MUST** store the unused lower anchor connector assembly, with all slack removed, in storage area on the back of the seat (page 47). Roll or fold excess lower anchor connector strap and secure with a rubber band to prevent serious injury to vehicle occupants.

#### **IMPORTANT:**

Center installation of this child restraint is permitted using inner Lower Anchor Bars from the outside seating positions if:

1. your vehicle manual allows such installation; and
2. the inner Lower Anchor Bars from the outside seating positions are 11-20 inches apart.

# 1

### **⚠ WARNING**

**NEVER** turn a child restraint **forward-facing** with a child who weighs less than 10 kg (22 lbs).

**Crash forces may cause serious injury or death.**

For complete child requirements for forward-facing use, see page 2.

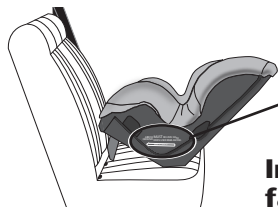

Infants **MUST** always ride facing the rear of the vehicle.

Adjust the child restraint to the **recline position** (page 38). Place the child restraint in your vehicle **rear-facing**. Adjust the restraint so that the level arrow **A** is level with the ground.

## Rear-facing Installation with Lower Anchor Connectors



# 2

### **⚠️ WARNING**

Make sure both harness straps are installed **completely** on the splitter plate, as shown. Failure to properly attach the harness straps to the splitter plate may result in a loose harness and serious injury or death to your child.

Attach the harness straps **B** to the splitter plate **C** using the **infant position** (page 37) on the harness straps. As your child grows, you can attach the harness straps **B** to the splitter plate using the pockets at the end of the straps.

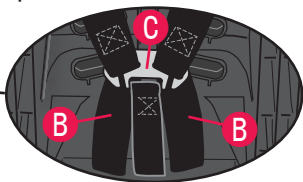
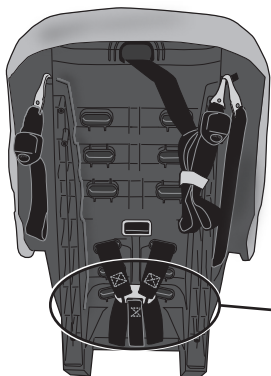

Rear-facing

# 3

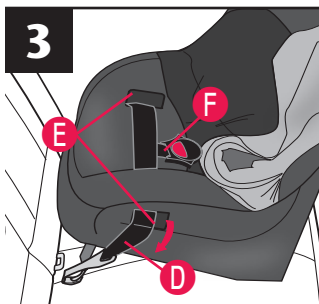

Pull the seat pad off of the front of the child restraint. Route the Lower Anchor Connector strap **D** and hook through the rear-facing belt paths **E**. **IMPORTANT:** Make sure the Lower Anchor Connector strap **D** is **in front of the crotch strap F**, and it lies flat without twisting, as shown. Reconnect the seat pad to the front of the child restraint.

## Rear-facing Installation with Lower Anchor Connectors

# 4

## **WARNING**

**DO NOT** use the upper harness slots **rear-facing**. The harness may not properly restrain the child during a crash.

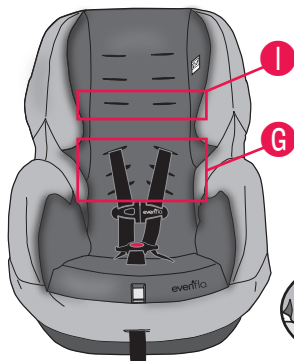

Make sure the harness straps are in one of the **three lower** strap slots **G**. The harness straps **MUST** start at shoulder height or lower, using the strap slots closest to your child's shoulders **H**, as shown.

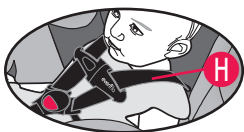

**U.S. Customers Only:** For a taller child, the fourth set of harness slots **I** can be used. **Note:** These slots **MUST** start at shoulder height or lower and be the closest slots to your child's shoulders.

# 5



## Know Your Lower Anchor Connector Assembly

The lower anchor connector assembly that comes with your child restraint will be one of the two types below.

### SecureRight™

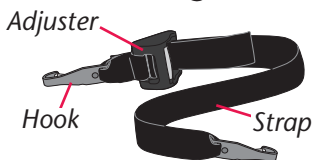

### Quick Connector™

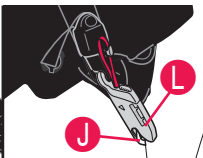
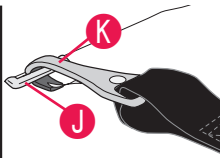
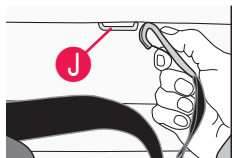
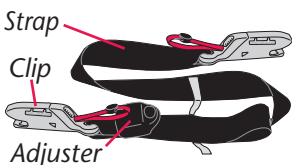

Refer to your vehicle owner's manual to locate the lower anchor bars **J** on your vehicle seat. Attach the right hook **K**, or clip **L**, to the right anchor bar **J** and the left hook, or clip, to the left anchor bar. **DOUBLE CHECK** that the lower anchor connector hook is fully engaged by pulling hard on the lower anchor connector strap.

## Rear-facing Installation with Lower Anchor Connectors



6

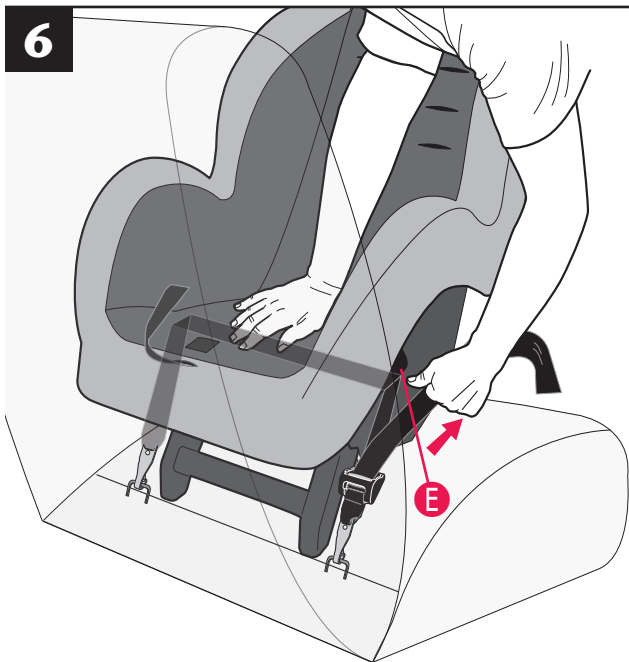

Rear-facing

### **⚠ WARNING**

**DO NOT** use this child restraint if it moves more than 25 mm (1 in.) side-to-side or front to back at the rear-facing belt path. Serious injury or death may result from poor installation. If you can not tightly secure the child restraint, try again or move it to another location, or install with the vehicle seat belt.

Using your full weight, push the child restraint firmly into the vehicle seat while pulling up on the lower anchor connector assembly strap to tighten.

**The lower anchor connector assembly strap must be as tight as possible.**

If you can move the child restraint more than 25 mm (1 in.) side to side or front to back at the rear-facing belt path **E**, the lower anchor connector assembly strap is not tight enough. You will need to try again, find another location for your child restraint, or install with the vehicle seat belt (page 22). To remove the lower anchor connector assembly strap, go to page 46.

## Rear-facing Installation with Seat Belt

1

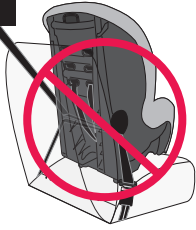

### **! WARNING**

**NEVER** turn a child restraint **forward-facing** with a child who weighs less than 10 kg (22 lbs). **Crash forces may cause serious injury or death.**

For complete child requirements for forward-facing use, see page 2.

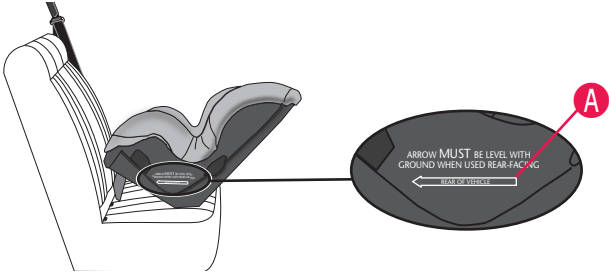

Infants **MUST** always ride facing the rear of the vehicle. Adjust the child restraint to the **recline position** (page 38). Place the child restraint in your vehicle **rear-facing**. Adjust the restraint so that the level arrow **A** is level with the ground.

2

### **! WARNING**

Make sure both harness straps are installed **completely** on the splitter plate, as shown.

Failure to properly attach the harness straps to the splitter plate may result in a loose harness and serious injury or death to your child.

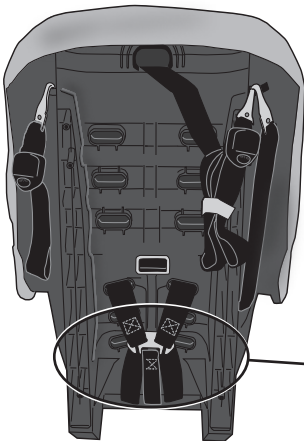

Attach the harness straps **B** to the splitter plate **C** using the **infant position** (page 37) on the harness straps. As your child grows, you can attach the harness straps **B** to the splitter plate using the pockets at the end of the straps.

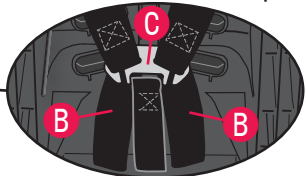



## Rear-facing Installation with Seat Belt

### 3

### **! WARNING**

**DO NOT** use the upper harness slots **rear-facing**. The harness may not properly restrain the child during a crash.



Make sure the harness straps are in one of the **three lower** strap slots **D**. The harness straps **MUST** start at shoulder height or lower, using the strap slots closest to your child's shoulders **E**, as shown.



Rear-facing

**U.S. Customers Only:** For a taller child, the fourth set of harness slots **F** can be used. **Note:** These slots **MUST** start at shoulder height or lower and be the closest slots to your child's shoulders.

### 4

#### Lap Belt Only

#### Lap & Shoulder Belt Combination

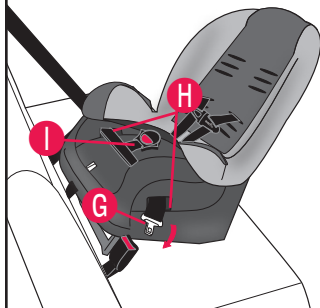
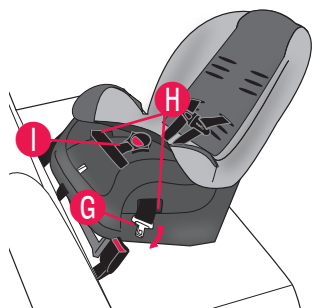

Pull the seat pad off of the front of the child restraint. Route the vehicle seat belt **G** through the rear-facing belt path **H** and continue through the opposite opening of the child restraint. **IMPORTANT:** Make sure the seat belt **G** is **in front of the crotch strap I**, and it lies flat without twisting, as shown. Fasten the vehicle seat belt, as shown, depending on your type of seat belt. Reconnect the seat pad to the front of the child restraint.

## Rear-facing Installation with Seat Belt

5

Locking Clip  
installed properly

13 mm  
(0.5 in.)

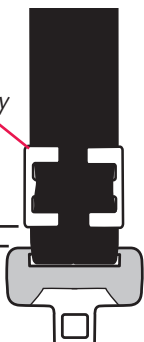

### **Install Locking Clip (not included), if necessary.**

If your vehicle was built **prior to model year 1996**, and has a lap/shoulder belt that is equipped with an emergency locking retractor (ELR) AND sliding latch plate, you **MUST** use a Locking Clip. Check your vehicle owner's manual to identify which vehicle belt system is in your vehicle.

If your vehicle is **model year 1996 or newer**, it likely has a vehicle belt system that can be locked when tightened, and will not require use of a Locking Clip.

**Consult your vehicle owner's manual before installing a locking clip.**

If your vehicle requires a Locking Clip, please call ParentLink at 1-800-233-5921 (U.S.) or 1-937-773-3971 (Canada), or 01-800-706-12-00 (Mexico). to obtain a Locking Clip and instructions on how to install and use it.

## **⚠ WARNING**

*Remove Locking Clip from vehicle seat belt when not used with a child restraint, or the vehicle seat belt will not properly restrain an adult or child. Serious injury could occur.*

## Rear-facing Installation with Seat Belt

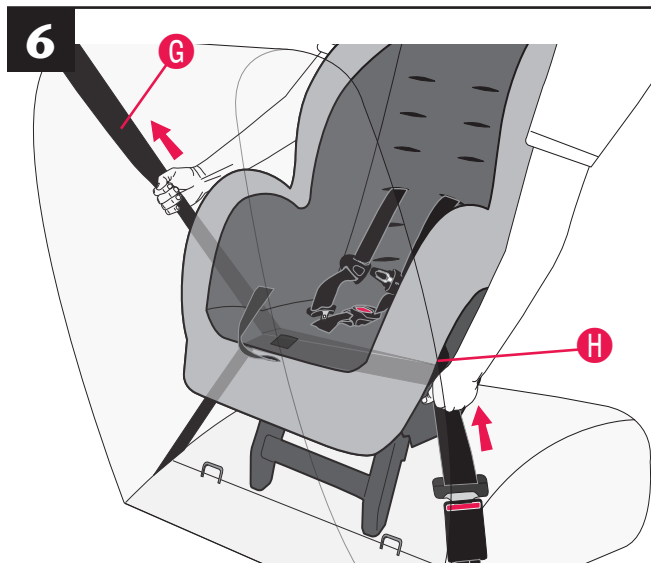

### **⚠ WARNING**

- If vehicle seat belts are not routed and fastened correctly, the child restraint may not protect your child in a crash.
- Check your vehicle owner's manual to determine how to lock your seat belt for child restraint installation. The seat belt must be locked to properly secure the child restraint.
- **DO NOT** use this child restraint if it moves more than 25 mm (1 in.) side to side or front to back at the rear-facing belt path. Serious injury or death may result from poor installation. If you can not tightly secure the child restraint, try again or move it to another location, or install with the lower anchor connector assembly.

#### **The seat belt must be as tight as possible.**

Put your full weight onto the child restraint as you tighten the seat belt **G**.

#### **Check your work.**

Make certain the belts are tight. If you can move the child restraint more than 25 mm (1 in.) side to side or front to back at the rear-facing belt path **H**, the vehicle belt is not tight enough. If you have not tightly secured the child restraint, try again, move it to another location, or install with the lower anchor connector assembly (p. 18).

# Using the Child Restraint Forward-facing

## Child Requirements:

- **Weight:** 10 to 29.4 kg (22 to 65 lbs)
- **Height:** 71 to 137 cm (28 to 54 in.) and tops of the child's ears are at or below the top of the child restraint seat back
- **Age:** At least 2 years old

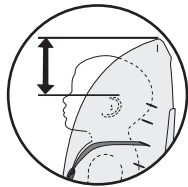

### IMPORTANT:

When installing this child restraint with Lower Anchor Connectors or the vehicle seat belt, always use the top anchorage strap (tether), if a tether anchor is available.

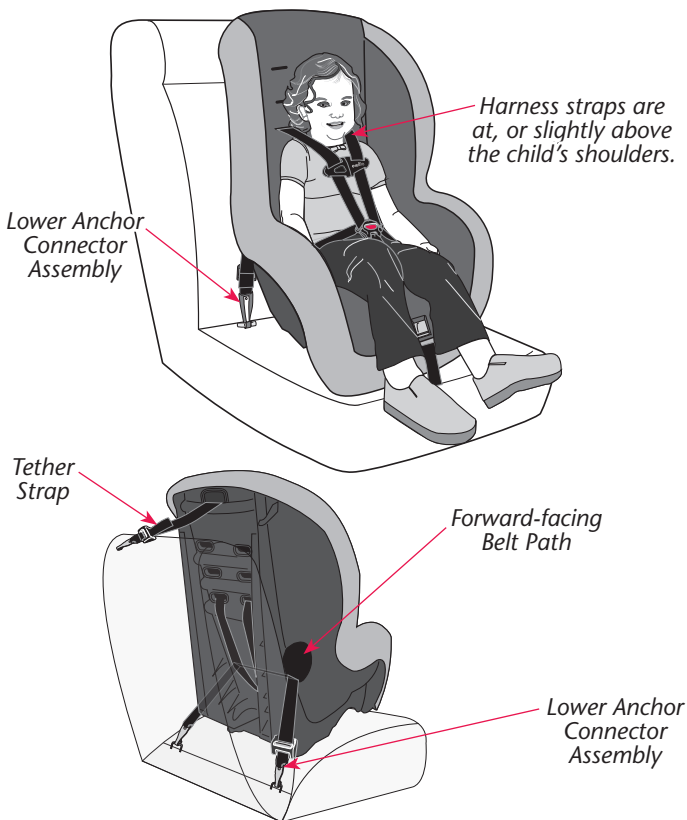

**IMPORTANT:** Once your child **exceeds** any of the size requirements for **forward-facing** use above, you **MUST** discontinue use of this child restraint. Consider use of a booster seat at that time.

# Forward-facing Installation Checklist

## 1. Secure child restraint to the vehicle seat.

- Recline stand is flipped to the **upright** position (page 38).
- Install with Lower Anchor Connector Assembly (page 28) **or** vehicle seat belt (page 32).
- Install tether strap (pages 31 and 35).
- Install locking clip, if necessary (page 33).

## 2. Set the child in the child restraint.

Tops of the child's ears are at, or below, the top of the child restraint seat back.

## 3. Fasten the buckle.

Refer to page 41.

## 4. Make necessary adjustments.

- Crotch strap is snug against the child (page 42).
- Harness straps **MUST** be snug against the child's shoulders, with no slack (page 41).

## 5. Position and connect chest clip.

Chest clip **MUST** be at armpit level (page 41).

## 6. Check your work.

- Recline Stand is flipped to the **upright** position (page 38).
- To properly secure this child restraint it **MUST NOT** move more than 25 mm (1 in.) from side to side or front to back at the forward-facing belt path (pages 30 and 34).
- The child's back and bottom are flat against the back and bottom surfaces of the child restraint (page 41).
- Shoulder harness straps **MUST** start at or above shoulder height, using the strap slots closest to your child's shoulders (page 36).
- Buckle tongues are fully engaged (page 41).
- Tether strap is securely attached and tightened (page 31 or 35).



## Forward-facing Installation with Lower Anchor Connectors

LATCH is a system for attaching the child restraint to your vehicle seat. It is to be used in place of your vehicle's seat belts and can be used in vehicles with LATCH anchors. **DO NOT install this child restraint with LATCH and the vehicle's seat belts. Your vehicle owner's manual may refer to this system as ISOFIX, Universal Anchorage System (UAS), or Lower Universal Anchorage System.**



**DO NOT** install by this method for a child weighing more than 24.9 kg (55 lb).

### **⚠ WARNING**

To avoid a strangulation hazard, you **MUST** store the unused lower anchor connector assembly, with all slack removed, in storage area on the back of the seat (page 47). Roll or fold excess lower anchor connector strap and secure with a rubber band to prevent serious injury to vehicle occupants.

#### **IMPORTANT:**

Center installation of this child restraint is permitted using inner Lower Anchor Bars from the outside seating positions if:

1. your vehicle manual allows such installation; and
2. the inner Lower Anchor Bars from the outside seating positions are 11-20 inches apart.

## Forward-facing Installation with Lower Anchor Connectors



1

### **⚠ WARNING**

**DO NOT** use the lowest set of harness slots for **forward-facing**. The harness may not properly restrain the child in the event of a crash.

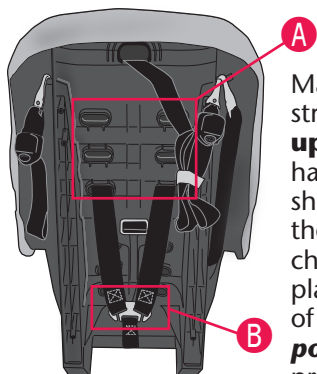

Make sure that the harness straps are in one of the **three upper strap slots A**. The harness straps **MUST** start at shoulder height or above, using the strap slots closest to your child's shoulders **C**. The splitter plate is attached to the bottom of the harness strap in the **child position B** (page 37). This will provide more room for your child to fit comfortably.

2

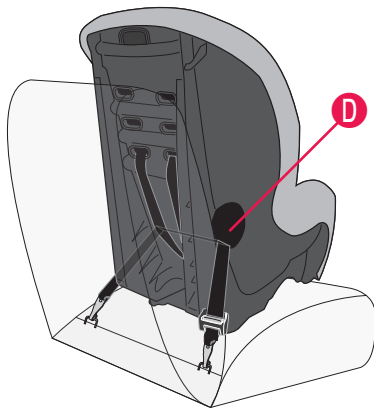

Forward-facing

Adjust the child restraint to the **upright position** (page 38) and place it in your vehicle **forward-facing**, as shown. Route the Lower Anchor Connector Assembly through each side of the forward-facing belt path **D**.

**Note:** Lift seat pad away from seat for easier access. Make sure Lower Anchor Connector Assembly strap lies flat without twisting.

## 3



## Know Your Lower Anchor Connector Assembly

The lower anchor connector assembly that comes with your child restraint will be one of the two types below.

### SecureRight

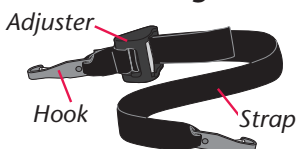

### Quick Connector

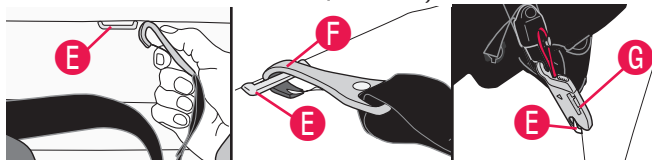
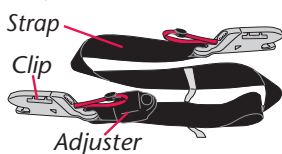

Refer to your vehicle owner's manual to locate the lower anchor bars **E** on your vehicle seat. Attach the right hook **F**, or clip **G**, to the right anchor bar **E** and the left hook, or clip, to the left anchor bar. **DOUBLE CHECK** that the lower anchor connector hook is fully engaged by pulling hard on the lower anchor connector strap.

## 4

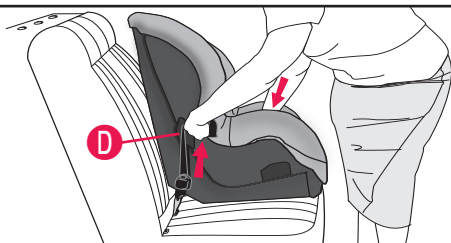

## **⚠ WARNING**

**DO NOT** use this child restraint if it moves more than 25 mm (1 in.) side-to-side or front to back at the forward-facing belt path. Serious injury or death may result from poor installation. If you can not tightly secure the child restraint, try again, move it to another location, or install with the vehicle seat belt.

Using your full weight, push the child restraint firmly into the vehicle seat, while pulling up on the lower anchor connector strap to tighten.

**The lower anchor connector strap must be as tight as possible.** If you can move the child restraint more than 25 mm (1 in.) side to side or front to back at the belt path **D**, the lower anchor connector strap is not tight enough. You will need to try again, find another location for your child restraint, or install with the vehicle seat belt (page 32). To remove the lower anchor connector strap, go to page 46.



## Forward-facing Installation with Lower Anchor Connectors



# 5

### **⚠ WARNING**

- Failure to follow these instructions could result in serious injury to your child or other vehicle occupants.
- The tether strap is for **forward-facing use only**.

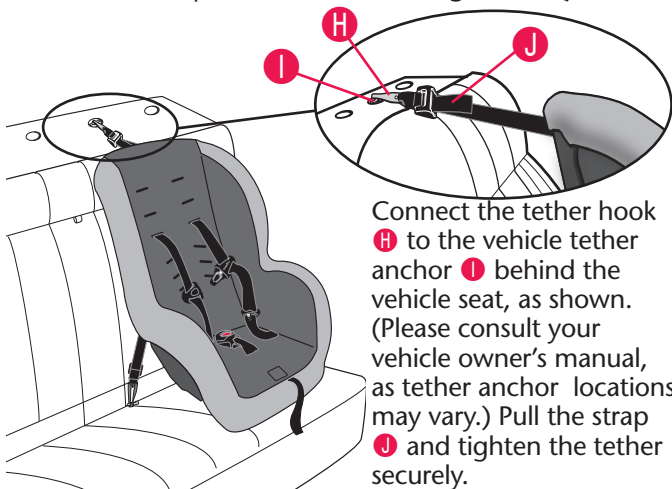

Connect the tether hook **H** to the vehicle tether anchor **I** behind the vehicle seat, as shown. (Please consult your vehicle owner's manual, as tether anchor locations may vary.) Pull the strap **J** and tighten the tether securely.

### **⚠ WARNING**

- To avoid a strangulation hazard, you **MUST** tightly roll or fold excess tether strap and secure with the strap/rubber band.
- Attach the tether hook to the storage clip when not in use. This will keep an unused tether or tether hook from hitting someone during a crash.

After adjusting the top tether strap, you may have excess strap; **DO NOT** cut it off. If you do, it may not be long enough to use in another vehicle. Instead, tightly roll up the excess tether strap and place the rubber band around the bundle.

**Note:** Refer to your vehicle owner's manual for the location of the tether anchor bracket in your vehicle. Older vehicles may not come equipped with anchor bracket hardware. Check with your vehicle dealer. If you have questions regarding tether anchors that are not addressed by the vehicle owner's manual or answered by an authorized dealer/vehicle manufacturer, call Evenflo's ParentLink at 1-800-233-5921 (U.S.) or 1-937-773-3971 (Canada), or 01-800-706-12-00 (Mexico).

Forward-facing

## Forward-facing Installation with Seat Belt

1

### **⚠ WARNING**

**DO NOT** use the lowest set of harness slots for **forward-facing**. The harness may not properly restrain the child in the event of a crash.

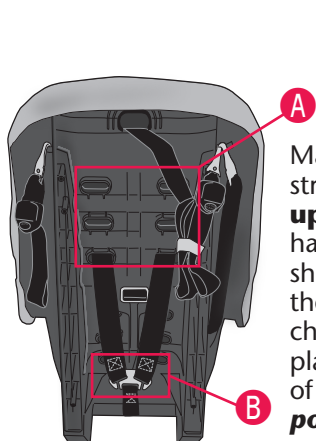

Make sure that the harness straps are in one of the **three upper** strap slots **A**. The harness straps **MUST** start at shoulder height or above, using the strap slots closest to your child's shoulders **C**. The splitter plate is attached to the bottom of the harness strap in the **child position** **B** (page 37). This will provide more room for your child to fit comfortably.

2

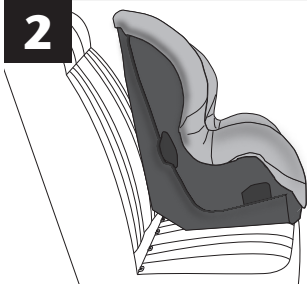

Adjust the child restraint to the **upright position** (page 38). Place the child restraint in your vehicle **forward-facing**.

3

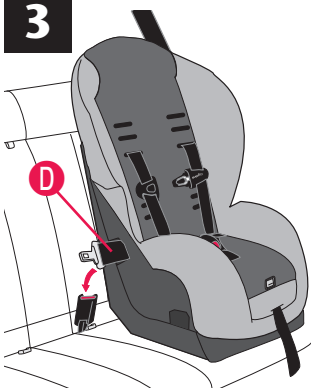

### **⚠ WARNING**

*If the vehicle belts are not routed and fastened correctly, the child restraint may not protect your child in a crash.*

Thread the vehicle seat belt **D** through the **forward-facing** belt path behind the seat pad.

**Note:** Lift seat pad away from seat for easier access. Make sure vehicle seat belt lies flat without twisting.

## Forward-facing Installation with Seat Belt

4

### Lap Belt Only

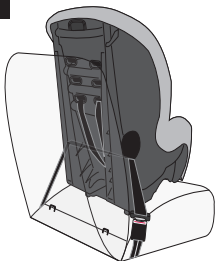

### Lap & Shoulder Belt

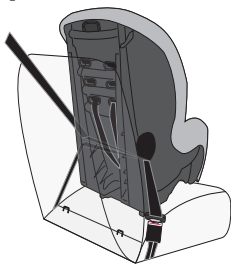

Fasten the vehicle seat belt as shown depending on your type of seat belt.

**Note:** Install locking clip on lap and shoulder belt combinations, if necessary.

5

Locking Clip  
installed properly

13 mm  
(0.5 in.)

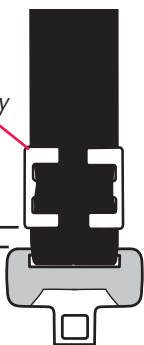

### Install Locking Clip (not included), if necessary.

If your vehicle was built **prior to model year 1996**, and has a lap/shoulder belt that is equipped with an emergency locking retractor (ELR) AND sliding latch plate, you **MUST** use a Locking Clip. Check your vehicle owner's manual to identify which vehicle belt system is in your vehicle.

If your vehicle is **model year 1996 or newer**, it likely has a vehicle belt system that can be locked when tightened, and will not require use of a Locking Clip.

**Consult your vehicle owner's manual before installing a locking clip.**

If your vehicle requires a Locking Clip, please call ParentLink at 1-800-233-5921 (U.S.) or 1-937-773-3971 (Canada), or 01-800-706-12-00 (Mexico) to obtain a Locking Clip and instructions on how to install and use it.

## **⚠️ WARNING**

Remove Locking Clip from vehicle seat belt when not used with a child restraint, or the vehicle seat belt will not properly restrain an adult or child. Serious injury could occur.

## Forward-facing Installation with Seat Belt

6

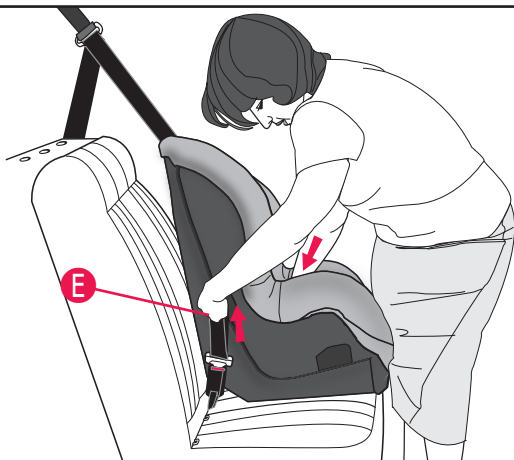

### **! WARNING**

- If vehicle seat belts are not routed and fastened correctly, the child restraint may not protect your child in a crash.
- Check your vehicle owner's manual to determine how to lock your seat belt for child restraint installation. The seat belt must be locked to properly secure the child restraint.
- **DO NOT** use this child restraint if it moves more than 25 mm (1 in.) side to side or front to back at the forward-facing belt path **E**. Serious injury or death may result from poor installation. If you can not tightly secure the child restraint, try again or move it to another location, or install with the lower anchor connector assembly (page 28).

#### **The vehicle seat belt must be as tight as possible.**

Using your full weight, push the child restraint firmly into the vehicle seat as you tighten the vehicle belt. If you can move the child restraint more than 25 mm (1 in.) side to side or front to back at the forward-facing belt path **E**, the seat belt is not tight enough, you will need to try again, or install with the lower anchor connector assembly (page 28).

## Forward-facing Installation with Seat Belt

7

### **! WARNING**



- Failure to follow these instructions could result in serious injury to your child or other vehicle occupants.
- The tether strap is for **forward-facing use only**.

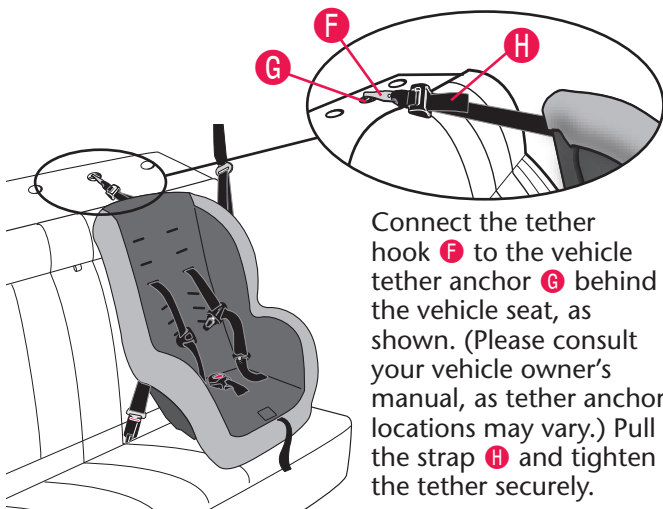

Connect the tether hook **F** to the vehicle tether anchor **G** behind the vehicle seat, as shown. (Please consult your vehicle owner's manual, as tether anchor locations may vary.) Pull the strap **H** and tighten the tether securely.

### **! WARNING**

- To avoid a strangulation hazard, you **MUST** tightly roll or fold excess tether strap and secure with the strap/rubber band.
- Attach the tether hook to the storage clip when not in use. This will keep an unused tether or tether hook from hitting someone during a crash.

After adjusting the top tether strap, you may have excess strap; **DO NOT** cut it off. If you do, it may not be long enough to use in another vehicle. Instead, tightly roll up the excess tether strap and place the rubber band around the bundle.

**Note:** Refer to your vehicle owner's manual for the location of the tether anchor bracket in your vehicle. Older vehicles may not come equipped with anchor bracket hardware. Check with your vehicle dealer. If you have questions regarding tether anchors that are not addressed by the vehicle owner's manual or answered by an authorized dealer/vehicle manufacturer, call Evenflo's ParentLink at 1-800-233-5921 (U.S.) or 1-937-773-3971 (Canada), or 01-800-706-12-00 (Mexico).

Forward-facing

# General Information

## Positioning the Harness Strap



Shoulder harness straps on this child restraint are adjustable to **six** positions.

### **Rear-facing:**

**U.S. Customers:** The shoulder harness straps **MUST** start at or below shoulder height using the strap slots closest to your child's shoulders in one of the four lower harness positions **A** and **B**. The child's head **MUST** be at least 25 mm (1 in.) below the top of the seat back.

**Canadian Customers:** The shoulder harness straps **MUST** start at or below shoulder height using the strap slots closest to your child's shoulders in one of the three lower harness positions **A**. The child's head **MUST** be at least 25 mm (1 in.) below the top of the seat back.

### **Forward-facing:**

You **MUST** use one of the top three harness positions **B** and **C**. If the tops of the child's ears are above the top of the seat back, the child's shoulders fall above the upper harness slots, or the child weighs more than 29.4 kg (65 lbs), you **MUST** discontinue use of this child restraint. We recommend that you move your child to a larger child restraint or a booster seat. You **MUST** use the harness slots at or above the child's shoulders **AND** closest to your child's shoulders.

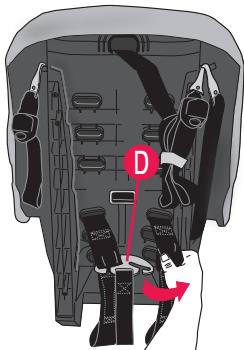
**1**

To change the harness strap position, loosen the shoulder harness as shown on page 43, step 2. Slide the harness strap off the splitter plate **D**.

**2**

Pull harness strap through to the front of the child restraint. Thread each harness strap through the appropriate slot. Pull the harness strap to the back of the child restraint.

**3**

## **⚠ WARNING**

*Make sure both harness straps are installed **completely** on the splitter plate, as shown. Failure to properly attach the harness straps to the splitter plate may result in a loose harness and serious injury or death to your child.*

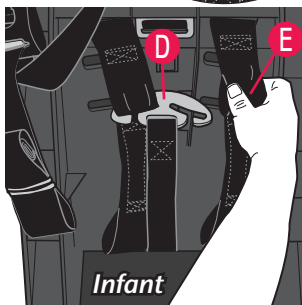
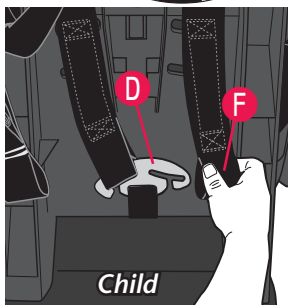
*Infant**Child**Infant**Child***General**

There are two positions on the harness straps. The top loop **E** is for infant use. The bottom loop **F** is for use as your child grows. Reattach the harness strap onto the splitter plate **D**. Repeat on the other side.

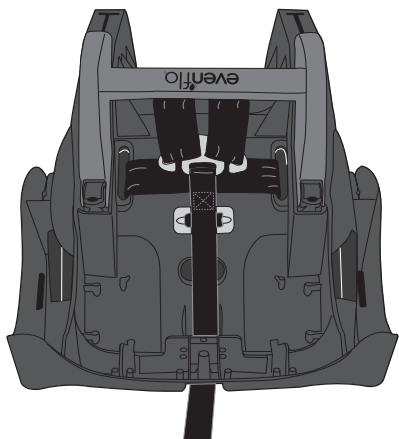

**Note:** Never route the harness belts over the recline stand.

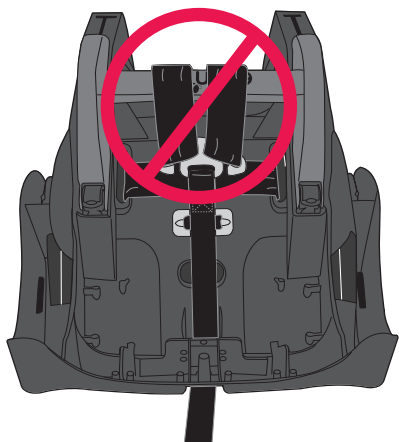

## ***Adjusting the Recline Stand***

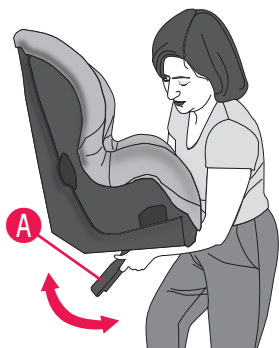

Lift the child restraint and flip the recline stand **A**, located under the child restraint seat, to either the **upright** or **recline position**.

**Note:** **Recline position** is to be used for rear-facing **ONLY**.

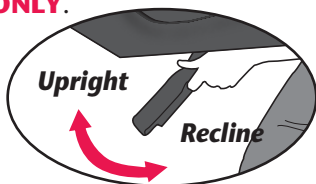



## FOR CANADIAN CONSUMERS ONLY:

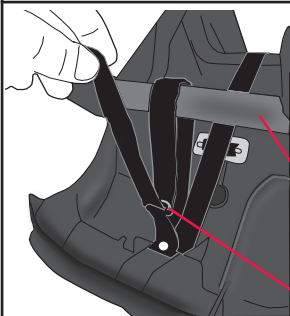

When the recline stand is in the **recline position**, wrap Velcro® strap around the recline stand **A** and insert the end of the strap through the D-ring **B**, as shown.

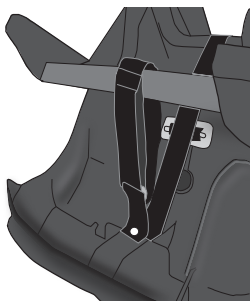

Pull until just taut and adhere Velcro to itself, as shown. (Overtightening could cause the strap to detach from the product).

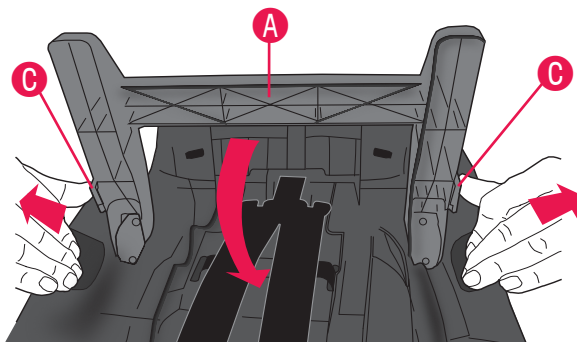

To fold the recline stand **A**, turn the child restraint upside down. Pull the shell walls away from the locking tabs **C** on the sides of the recline stand and rotate the recline stand downward until it lies flat, as shown.

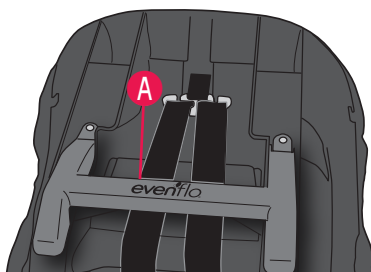

## Rear-facing Recline

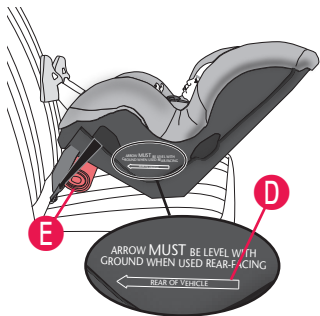

The child restraint **MUST** be in the **RECLINE** position for rear-facing use. Child **MUST** weigh 2.3 to 18 kg (5 to 40 lbs).

If the level arrow **D** is not parallel to the ground, use a tightly rolled towel or small blanket **E** beneath the front edge of the recline stand.

## Forward-facing Upright

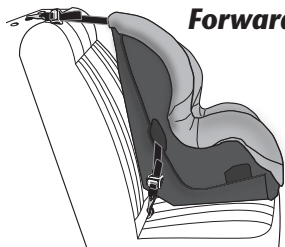

The child restraint **MUST** be in the **UPRIGHT** position for forward-facing use.

Child **MUST** weigh 10 to 29.4 kg (22 to 65 lbs) and be at least 2 years old.

# Securing the Child in the Child Restraint



Place baby in the child restraint. **The baby's back and bottom should be flat against the restraint.** If there is a gap, the baby will not be comfortable.

1

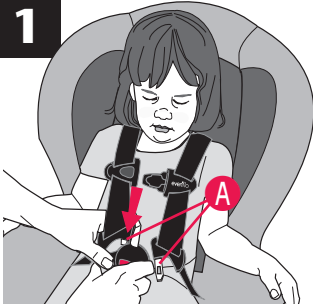

Bring each harness strap over the child's shoulders. Insert the buckle tongues **A** into the buckle.

Pull up on the harness strap to check that the buckle tongues are fastened.

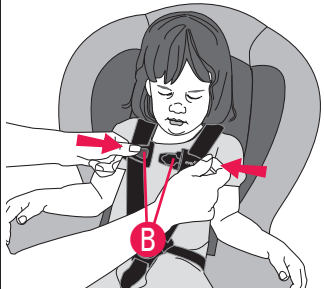

Fasten the chest clip **B** by snapping the two halves together, as shown.

Slide chest clip to armpit level.

2



The harness straps must be snug against the child. A snug strap should not allow any slack. It lies in a relatively straight line without sagging. It does not press on the child's flesh or push the child's body into an unnatural position. Check the harness straps near the shoulders for slack. You should **NOT** be able to pinch the harness (see illustration). Adjust as needed.

## Adjusting the Crotch Strap

### This Child Restraint Has Two Crotch Strap Positions

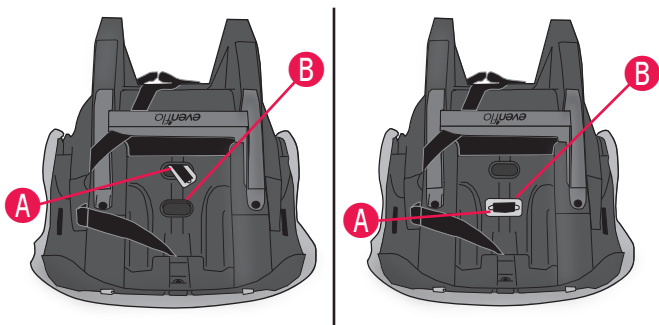

To reposition the crotch strap, first turn the child restraint upside down. Turn the crotch strap harness anchor **A** sideways and push it through the slot in the bottom of the seat shell **B**.

Reposition the harness anchor into the other slot. Make certain the harness anchor is properly seated against the seat shell **B**.

**Note:** The crotch strap should be snug against the child. Choose the slot that is closest to the child **AND** the most comfortable for the child but **NEVER** under the child's bottom.

### For Newborn Position

Place the anchor **A** through the rear slot, then feed it through the front slot.

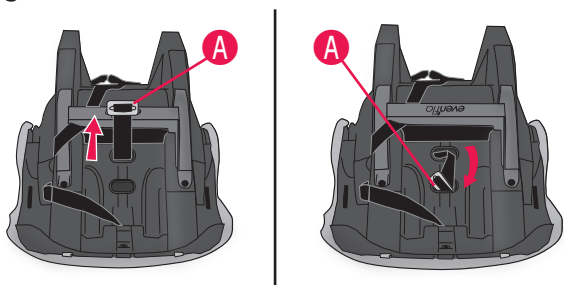

Make sure the anchor is completely through the front slot and is lying flat against the bottom of the seat.

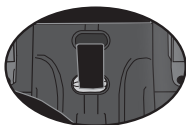

**IMPORTANT:** Do not use this configuration for infants weighing more than 4.5 kg (10 lbs).

## Adjusting the Harness Strap

1

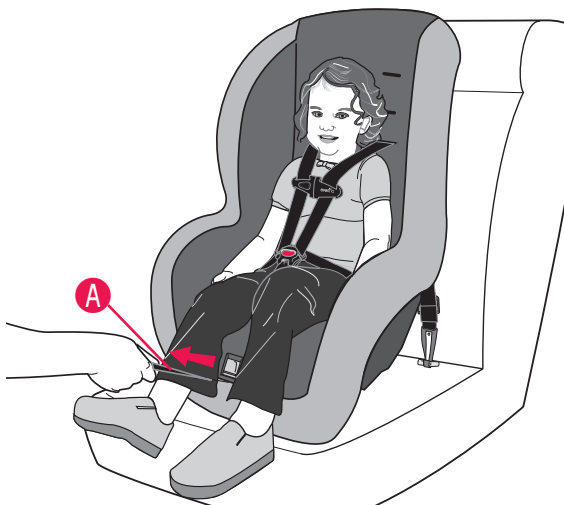

To tighten the harness straps, pull on the long harness adjuster strap **A** on the front of the seat.

2

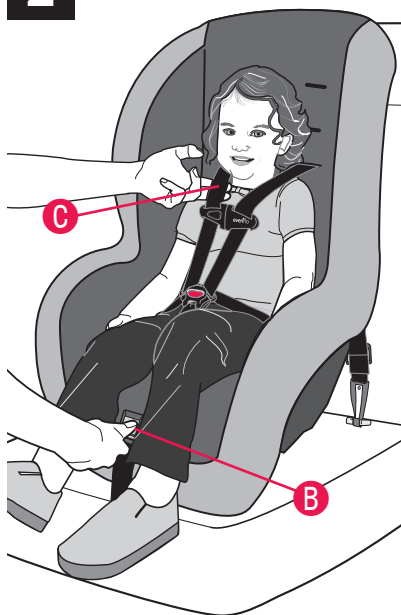

To loosen the harness straps, push the harness release button **B** on the front of the seat. At the same time, pull up on the harness strap **C** near the child's shoulders.

# Removing the Child from the Child Restraint

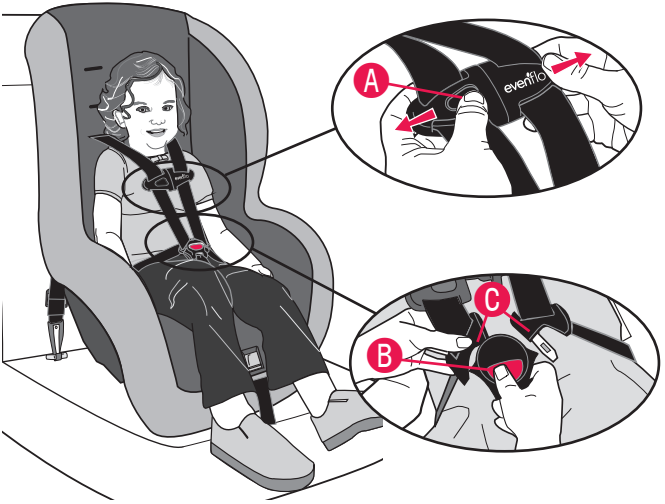

Push the release button **A** and pull the chest clip apart. Press the red buckle release **B** and remove the buckle tongues **C**.



## Removing the Tether Strap

**1**

The tether strap that comes with your child restraint will be one of the two types below.

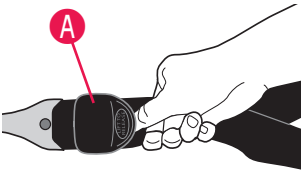

Tilt the adjuster **A** and slide the strap to loosen.

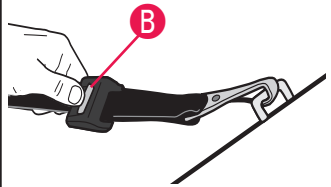

Press the adjuster release button **B** to loosen.

**2**

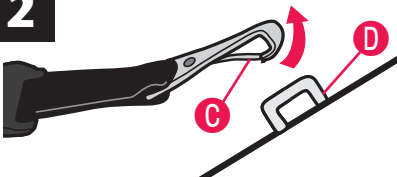

Press the tab **C** and twist, then remove the hook from the anchor **D**.

# 3

## **⚠ WARNING**

- To avoid a strangulation hazard, you **MUST** tightly roll or fold excess tether strap and secure with the strap/rubber band.
- Attach the tether hook **E** to the storage clip when not in use. This will keep an unused tether or tether hook from hitting someone during a crash.

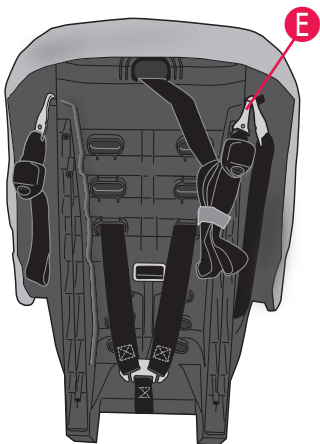

## Removing the Lower Anchor Connectors

1

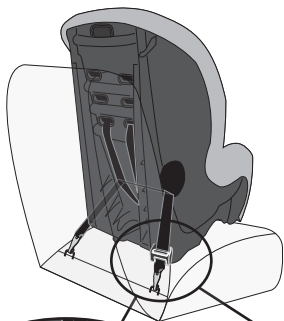

**Tip!**

Using your full weight, push the child restraint into the vehicle seat while loosening the adjuster.

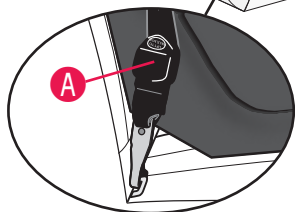

Or

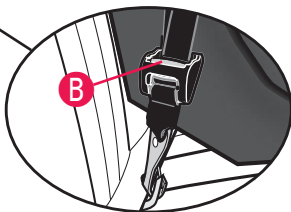

Tilt the adjuster **A** and slide the strap to loosen.

Press the adjuster release button **B** to loosen.

2

The Lower Anchor Connector that comes with your child restraint will be one of the two types below.

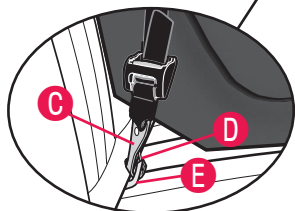
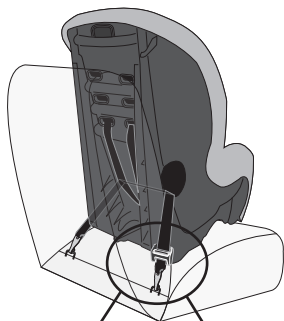

Or

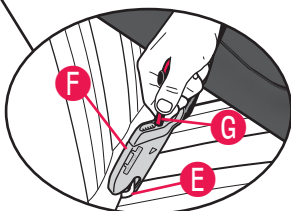

To remove the hook **C**, press the tab **D** and twist, then remove from anchor **E**.

To remove the clip **F**, pull the red release strap **G** and remove clip from anchor **E**.



## Removing the Lower Anchor Connectors

3

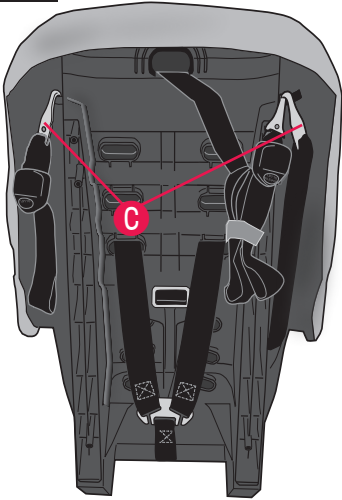

When the Lower Anchor Connector assembly is not in use you **MUST** attach the hooks **C** to the back of the child restraint. A loose Lower Anchor Connector assembly strap and hook may injure your child.

## Installing the Optional Accessories

1

Not available on all models. Styles may vary.



### **⚠ WARNING**

- Use the cup holder with the child restraint in the **forward-facing** position **ONLY**.
- **DO NOT** use the cup holder to store cans or hard cups. Only for use with soft cups.
- **DO NOT** place any cups that contain hot liquids in the cup holder.
- **DO NOT** attach any other items to this child restraint unless it has been certified for use with this specific child restraint.

To install the cup holder **A**, move seat pad **B** out of the way and install the cup holder onto the side of the restraint.

**2**

**Note:** The optional Infant Head Support and Body Pillow are for **Rear-facing** use only.

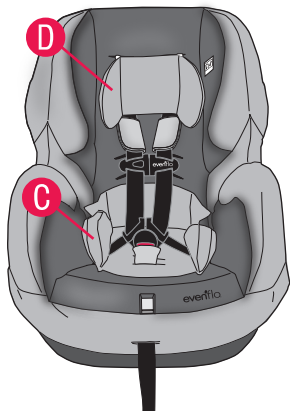

The optional Body Pillow **C**, when placed in the restraint, as shown, helps support your child.

The optional Infant Head Support **D** should lie flat against the seat back, as shown. Be sure to cut off the plastic attachment between the head support and the seat pad. Small parts may be a choking hazard.

**Note:** Attach Infant Head Support through harness slots just above harness straps.

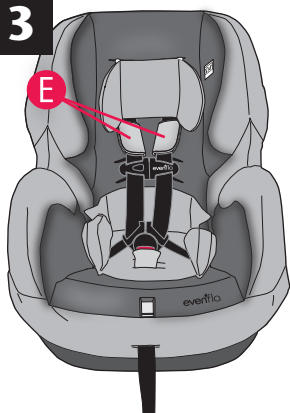
**3**

To remove the harness covers **E**, follow steps for Positioning the Harness Strap (p. 36). After Step 2, slide harness covers off harness straps. Continue with Step 3.

To reattach harness covers **E**, follow steps for Positioning the Harness Strap (p. 36). After Step 2, slide harness covers over harness straps. Continue with Steps 3.

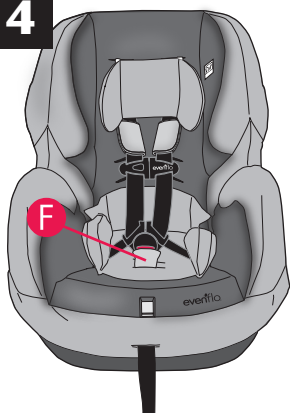
**4**

To remove the buckle cover **F**, press the red buckle release under the buckle cover, and remove buckle tongues. Pull buckle cover off the buckle.

To reattach the buckle cover **F** press the red buckle release, and remove buckle tongues. Push the buckle cover onto the buckle.



## Securing Your Child Restraint in Aircraft

The Federal Aviation Administration (FAA) recommends that you secure your child for air travel in an appropriate child restraint based on your child's weight and size. Turbulence can happen with little or no warning. When turbulence occurs, **the safest place for your child is in a properly installed child restraint, not in an adult's lap or on the aircraft seat with its seat belt.** Keeping your child in a child restraint during the flight will help ensure your family arrives safely at your destination.

The FAA recommends that a child weighing:

- more than 18 kg (40 lbs) use an aircraft seat belt;
- less than 9 kg (20 lbs) use a rear-facing child restraint; and
- from 9 to 18 kg (20 to 40 lbs) use a forward-facing child restraint.

**Please note that these FAA recommendations may vary from those applicable to the use of your child restraint in a motor vehicle.**

## Installing Child Restraint Rear-facing in Aircraft

**IMPORTANT:** Before installing the child restraint, make sure the **aircraft seat is in a fully upright position.**

1

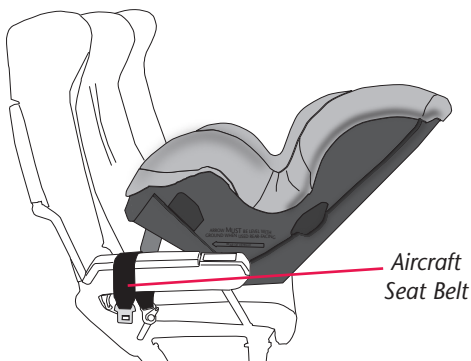

Adjust the child restraint to its **recline position** (page 38), then place it on the aircraft seat **rear-facing**, as shown above.

## Installing Child Restraint Rear-facing in Aircraft



2

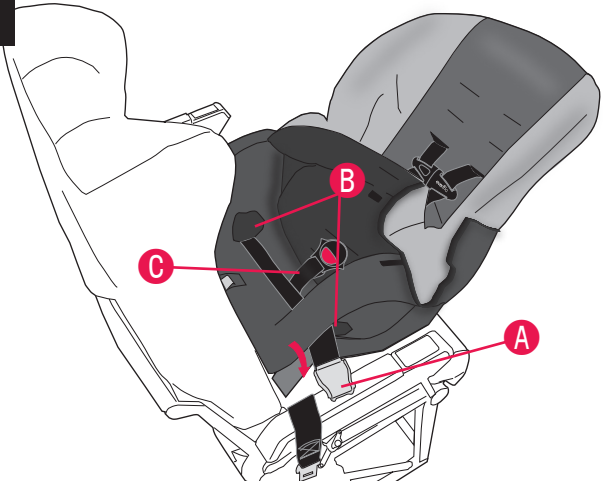

Pull the seat pad off the front of the child restraint. Route the aircraft seat belt **A** through the rear-facing belt path **B** opening on one side and continue through the belt path opening on the opposite side of the child restraint, as shown above.

**IMPORTANT:** Make sure the aircraft seat belt **A** is **in front of the crotch strap C**, as shown above.

3

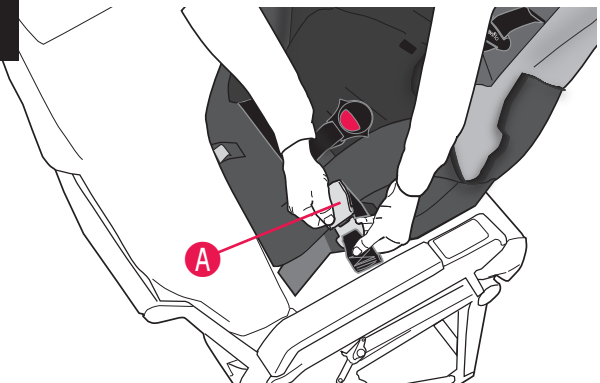

Fasten the aircraft seat belt **A**.

## **Installing Child Restraint Rear-facing in Aircraft**

**4**

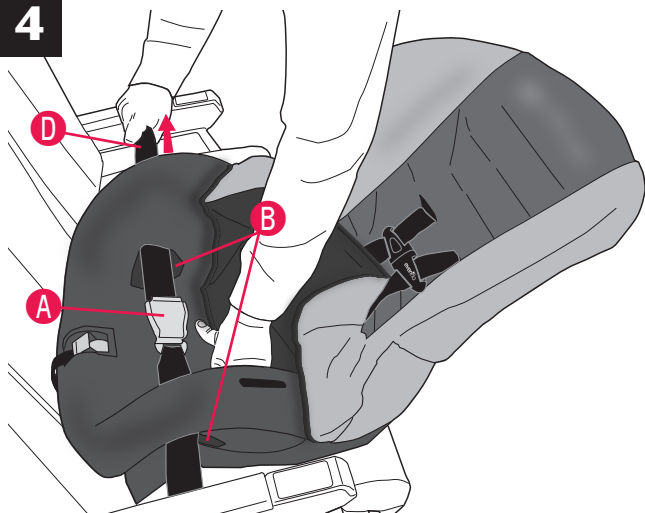

The aircraft seat belt **A** must be as tight as possible. Route the excess seat belt strap **D** back through the rear-facing belt path **B** opening, as shown above. Using your full weight, push the child restraint firmly onto the aircraft seat while pulling on the excess seat belt strap to tighten.

**Check your work.** Reconnect the seat pad to the front of the child restraint. Try to move the child restraint in all directions. If you can move the restraint more than 25 mm (1 in.) from side to side or front to back at the rear-facing belt path **B**, the aircraft seat belt **A** is not tight enough, and you **MUST** install again until the seat belt is tight.

# Installing Child Restraint Forward-facing in Aircraft



**IMPORTANT:** Before installing the child restraint, make sure the **aircraft seat is in a fully upright position.**

1

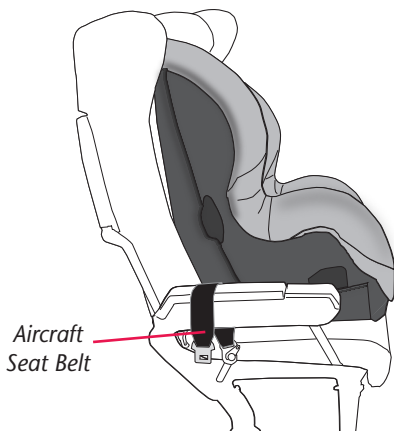

Adjust the child restraint to its **upright position** (page 38), then place it on the aircraft seat **forward-facing**, as shown above.

2

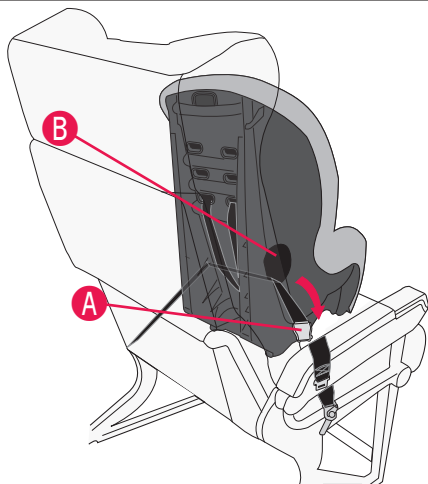

Route the aircraft seat belt **A** through the forward-facing belt path opening in the back of the child restraint and continue through the belt path opening **B** on the opposite side of the child restraint.

**Note:** Lift the restraint's seat pad away for easier access.

## **Installing Child Restraint Forward-facing in Aircraft**

**3**

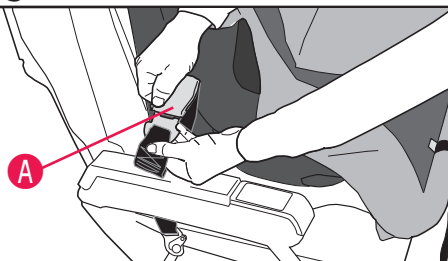

Fasten the aircraft seat belt **A**.

**4**

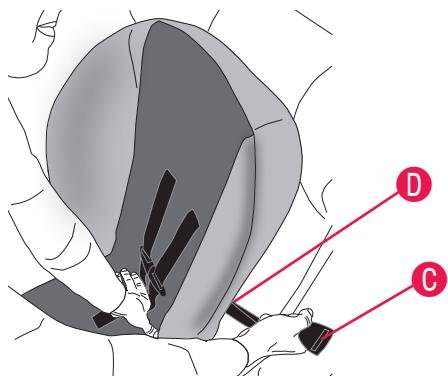

The aircraft seat belt must be as tight as possible. Route the excess aircraft seat belt strap **C** back through the forward-facing belt path **D** opening, as shown above. Using your full weight, push the child restraint firmly onto the aircraft seat while pulling on the excess seat belt strap to tighten.

**Note:** Because of the fixed length of aircraft seat belts, the belt buckle could be behind the child's back after tightening the belt. For your child's comfort, Evenflo recommends cushioning the child's back by placing a small pillow or folded-up blanket, or a folded-up jacket, over the belt buckle.

**Check your work.** Reconnect the seat pad to the front of the child restraint. Try to move the child restraint in all directions. If you can move the restraint more than 25 mm (1 in.) from side to side or front to back at the forward-facing belt path, the aircraft seat belt is not tight enough, and you **MUST** install again until the seat belt is tight.



## Care and Cleaning

- **DO NOT** lubricate or immerse in water the LATCH connectors, the buckle, or any other part of this child restraint, unless rinsing is permitted, as stated on the back of the buckle for your restraint.
- Plastic and metal parts may be wiped clean with mild soap and water and dried with a soft cloth. Do not use abrasive cleaners or solvents.
- Take care not to damage any labels.
- The harness can be wiped clean with mild soap and water. Allow harness to air dry.
- Machine wash the seat pad separately in cold water, delicate cycle. Tumble dry 10 to 15 minutes on low heat.
- **NEVER** use child restraint without the seat pad.
- To protect the child restraint from damage caused by weather, rodents, and other elements common to garages, the outdoors, and other storage locations, remove the seat pad and thoroughly clean the restraint and pad prior to storage. Take care to clean in the areas where crumbs and other debris tend to accumulate.

**Tip!**

*To help protect the vehicle upholstery, place a towel beneath and behind the child restraint.*

# Replacement Parts

*Not available on all models. Styles may vary.*

To order replacement parts, you can order online at [www.evenflo.com](http://www.evenflo.com) or contact Evenflo. When you contact us, please have the product model number and date of manufacture (found on the back of the child restraint).



- 1 Locking Clip:  
Not included with child restraint, see page 24 or 33



- 2 Chest Clip



- 3 Crotch Strap



- 4 Harness



- 5 Tether



- 6 Tether Extender:  
Not included with child restraint



- 7 Lower Anchor Connector Assembly

Or



- 8 Lower Anchor Connector Assembly with Quick Connectors



- 9 Cup Holder



- 10 Head Foam



- 11 Buckle Cover



- 12 Harness Covers

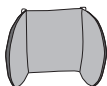

- 13 Head Pillow

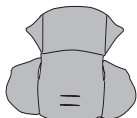

- 14 Body Pillow

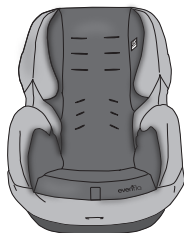

- 15 Seat pad

## Proper Disposal of This Child Restraint

At the end of this child restraint's useful life, Evenflo encourages you to dispose of it properly. Most of the components in this child restraint are recyclable.

1. Remove all fabric and padding.
2. Remove all screws and disassemble the restraint.
3. Recycle all plastic/foam parts and discard the rest.

If your local recycling center won't accept the padding, you may dispose of it in the landfill.

## Limited Warranty

For a period of 90 days from the original purchase of this Product, Evenflo warrants to the original end user (“Purchaser”) this Product (including any accessories) against defects in material or workmanship. Evenflo’s sole obligation under this express limited warranty shall be, at Evenflo’s option, to repair or replace any Product that is determined to be defective by Evenflo and determined to be covered by this warranty.

Repair or replacement as provided under this warranty is the exclusive remedy of the Purchaser. Proof of purchase in the form of a receipted invoice or bill of sale evidencing that the Product is within the warranty period must be presented to obtain warranty service. This express limited warranty is extended by Evenflo ONLY to the original Purchaser of the Product and is not assignable or transferable to subsequent purchasers or end users of the Product. For warranty service, contact Evenflo’s ParentLink Consumer Resource Center.

EXCEPT TO THE EXTENT PROHIBITED BY APPLICABLE LAW, ANY IMPLIED WARRANTY OF MERCHANTABILITY OR FITNESS FOR A PARTICULAR PURPOSE ON THIS PRODUCT IS HEREBY DISCLAIMED. EVENFLO SHALL NOT BE LIABLE FOR ANY INCIDENTAL, CONSEQUENTIAL, SPECIAL OR PUNITIVE DAMAGES OF ANY KIND FOR BREACH OF THE EXPRESS LIMITED WARRANTY ON THIS PRODUCT, OR ANY WARRANTY IMPLIED BY OPERATION OF LAW. OTHER THAN THE EXPRESS LIMITED WARRANTY SET FORTH ABOVE, THERE ARE NO OTHER WARRANTIES THAT ACCOMPANY THIS PRODUCT AND ANY ORAL, WRITTEN OR ANY OTHER EXPRESS REPRESENTATION OF ANY KIND IS HEREBY DISCLAIMED.

**ParentLink®**

answers. advice. affirmation.™

• **[www.evenflo.com](http://www.evenflo.com)**

- USA: 1-800-233-5921 8 AM – 5 PM E.T.
- Canada: 1-937-773-3971
- México: 01-800-706-12-00

## ParentLink®

answers. advice. affirmation.™

- **[www.evenflo.com](http://www.evenflo.com)**
- *USA: 1-800-233-5921 8 AM – 5 PM E.T.*
- *Canada: 1-937-773-3971*
- *México: 01-800-706-12-00*